

# EXPLORER 1500 PRO

## Assembly Manual

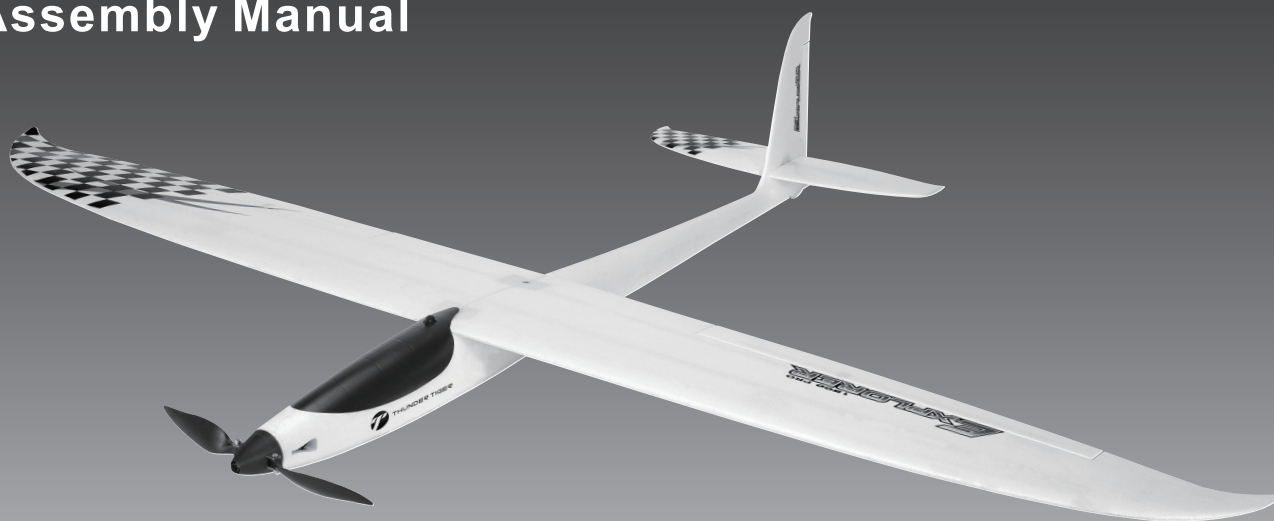

### Specifications

**Wing Span:** 59-1/16" (1500mm)

**Length:** 40" (1016mm)

**Weight:** 2.2 lbs. (1000g)

**No.4385-F00**

## WARRANTY

Thunder Tiger Corporation guarantees this model kit to be free from defects in both material and workmanship. The total monetary value under warranty will in no case exceed the cost of the original kit purchased. This warranty does not cover any components damaged by use or modification. Part or parts missing from this model must be reported within 60 days of purchase. No part or parts will be sent under warranty without proof of purchase. To receive part or parts under warranty, the service center must receive a proof of purchase and/or the defective part or parts. Should you find a defective or missing part, contact the authorized Thunder Tiger Service/Distributor nearest you. Under no circumstances can a dealer or distributor accept return if assembly has started.

## NOTICE: ADULT SUPER VISION REQUIRED

This is not a toy. Assembly and flying of this product requires adult supervision.

Read through this book completely and become familiar with the assembly and flight of this airplane. Inspect all parts for completeness or damage. Contact authorized distributors for customer service if you encounter any problem.

Thank you for your purchase of the Explorer 1500, a great choice to relax yourself to fly in blue sky with this environmentally friendly glider. Features lite and durable EPO material, efficient C2415-1150KV motor and advanced folding propeller make this glider high power-to-weight ratio for ultra performance and rapid climbing.

Explorer is speicly designed for intermediate to advance pilots. Before beginning the assembly read this introduction thoroughly to gain an understanding of the sequence of your kit. If you find any of the parts are either missing or damaged, please contact the authorized distributors for customer service.

Thank you for purchasing the "Explorer 1500" remote control model airplanes from THUNDER TIGER, and we hope this plane will bring endless joy to you after you choose it.

1. Explorer 1500 is a sport glider for intermediate to advance pilots with basic flying skill and experience.
2. High Speed, stable flight and easy to control. Explorer 1500 can achieve axial rolls, inverted flight, inside loops, outside loops and other aerobatic actions.
3. With modular and humanization design, Explorer 1500 is easy to carry and maintain.
4. With automatic heat dissipation function in power system, it ensures the high efficiency and prolongs the use life of the motor, ESC and battery for Explorer 1500.
5. With many Carbon Fiber reinforced Polymer material, it ensures the strong structure in the flight.

## INDEX

|                             |    |
|-----------------------------|----|
| IMPORTANT NOTES & WARRANTY  | 00 |
| INTRODUCTION                | 01 |
| CONTENT                     | 01 |
| ASSEMBLY PROCEDURE          | 02 |
| ADJUSTMENT STEPS            | 03 |
| CONFIRMATION OF CG LOCATION | 03 |
| SAFETY PRECAUTIONS          | 03 |
| SPARE PARTS                 | 04 |
| DISCLAIMER                  | 05 |
| DECLARATION OF CONFORMITY   | 07 |

## CONTENT

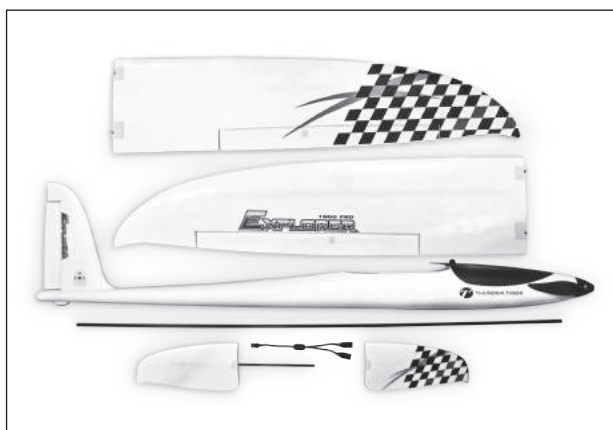

Fuselage, main wings, horizontal tails, connecting rods and Y harness as shown in the picture.

### OTHER ITEMS REQUIRED

A checklist is provided as below which will makes shopping for these items easier.



#### Transmitter

Transmitter (4CH) with Receiver are highly recommended.



#### Battery

Recommend the use of a 3S (11.1V) 2200mAh 20C LiPo Battery.



#### LiPo Charger



## 1. Horizontal tail assembly

Locate the two halves of horizontal tail and carbon joiner. Insert the carbon joiner in one half of horizontal tail then attach to the fuselage. Next insert the other half of the tail and make sure two halves are all the way in. Loosen the screws are required for easy installation.

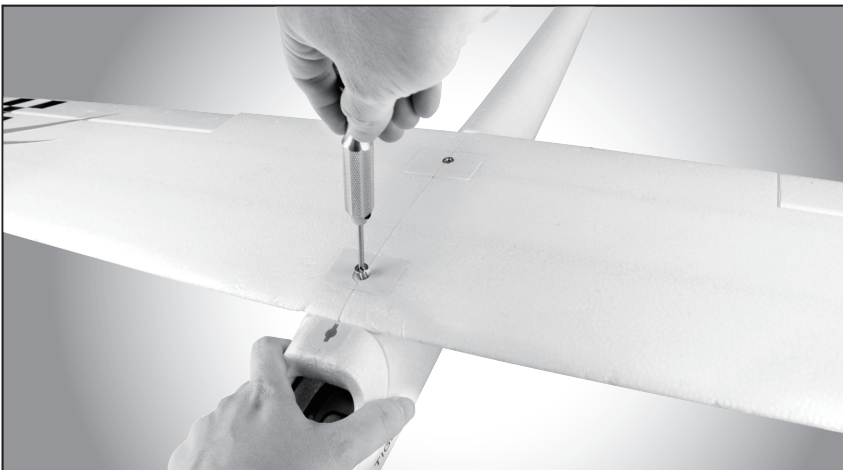

## 2. Main wing assembly

Locate the main wing, Y harness, main wing joiner and wing bolts. Firstly join to main wing with main wing joiner inserted. Well route the servo wires then connect the Y harness. If you use a programmable radio then we suggest you use the extension cord to the receiver and set up the Flapron function. Connect the servo wires to the receiver then test the aileron servos then secure the main wing in place with the wing bolt. Make sure there is no gap between two wing halves and fuselage. Also check the main wing and horizontal tail are parallel if you see from the nose.

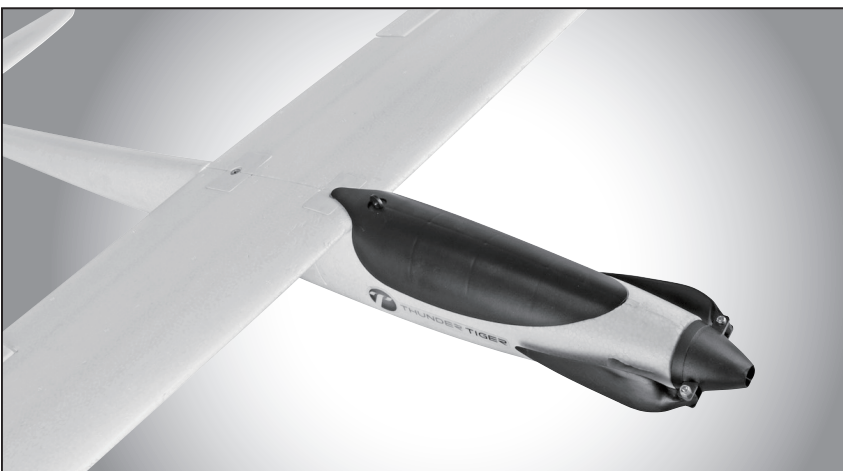

## 3. Canopy Installation

Attach the canopy and secure it in place by rotating 90-degree of the latch.

# ADJUSTMENT STEPS

---



When the servo arm is at the natural position under power on, please adjust the horizontal tail leverly as shown in the picture.

# CONFIRMATION OF CG LOCATION

---

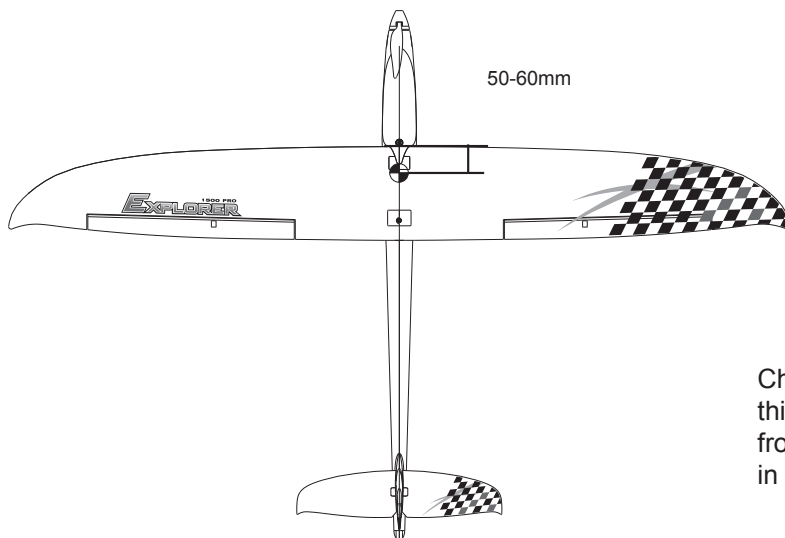

Check the center of gravity and make sure the CG of this plane should be within the range 50-60mm away from the leading edge of the main wings as indicated in the picture.

# SAFETY PRECAUTIONS

---

1. If you have the simulator, we suggest that you can practice your skill by the simulator before you fly this model, which will bring some help for you.
2. Please climb the plane above the 50 meters with half throttle to fly it when you fly it for your first time, then you will be familiar with the performance of this plane.
3. You should learn how to control this model blandly, it will reduce the possibility of crash and prolong the usage life of the plane.
4. The turn radius should not be too little, or it will stall and it will increase the possibility of crash.
5. When taking off or landing the plane, you should against the wind.
6. Do not fly the model over your head or behind you, you should fly the model in front of you.

# SPARE PARTS

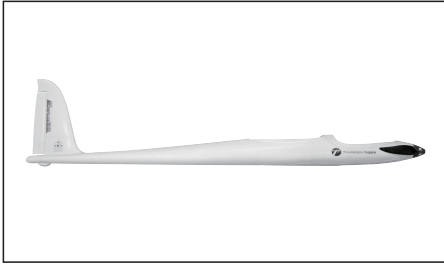

AS2001  
FUSELAGE SET

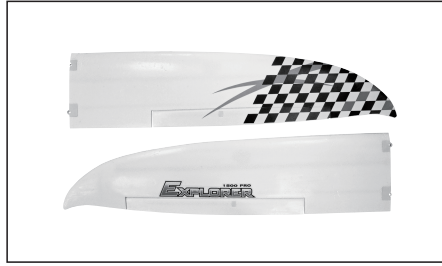

AS2002  
MAIN WING SET

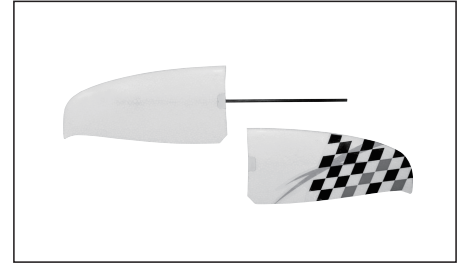

AS2003  
HORIZONTAL TAIL SET

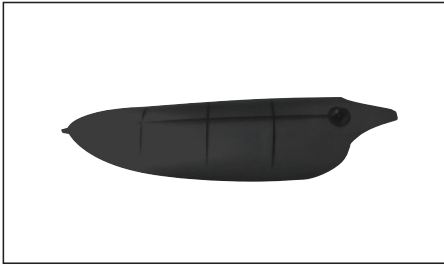

AS2004  
CANOPY SET

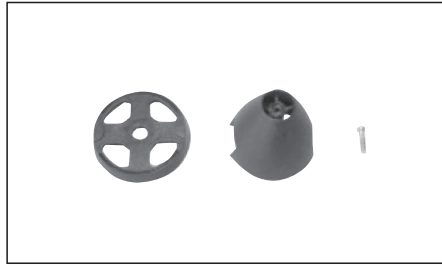

AS2005  
SPINNER SET

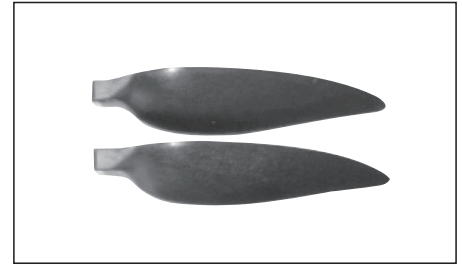

AS2006  
10x8 BLADE



AS2007  
CONNECTING ROD

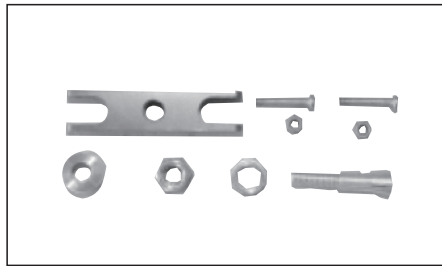

AS2008  
PROP HOLDER

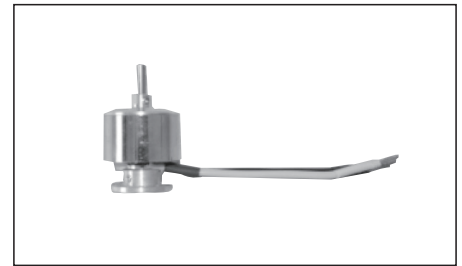

AS2009  
OUT RUNNER BRUSHLESS  
C2415-1150KV

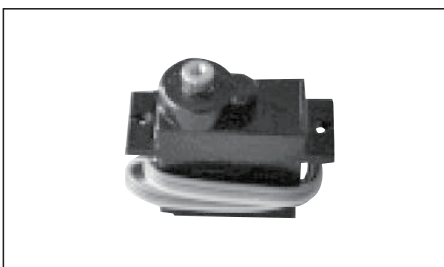

AS2010  
9G SERVO (METAL GEAR)

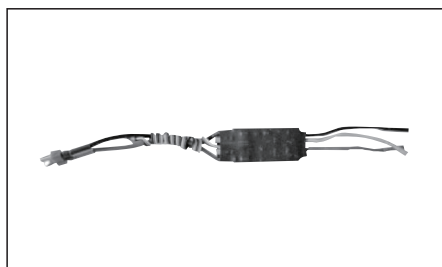

AS2011  
40A CONTROLLER

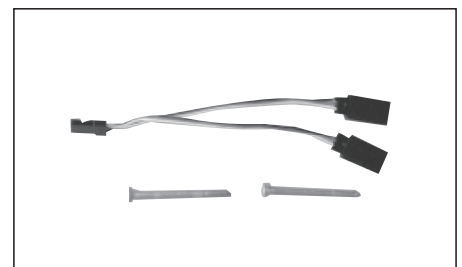

AS2012  
Y HARNESS



AS2013  
9G SERVO (PLASTIC GEAR)  
WIRE:400MM

## GENERAL STATEMENT

- All Thunder Tiger products are high-precision, which any misuse may result in damage to property, injury, or even death. The user must conform to the law and use the equipment responsibly.
- This product is not recommended for people under the age of 18. User agrees that he/she is responsible for his/her own conduct and content while using this product, and for any consequences thereof.
- Please read the instruction manual and tutorial videos before using the product.
- By using this product, user hereby agrees to this disclaimer and signify that user have read them fully. User agrees to use this product only for purposes that are proper and in accordance with the terms and any applicable policies or guidelines Thunder Tiger may make available.

## WARNING

- Please keep this product out of reach of children under 3 years old.
- Always use this product away from people and dangers such as buildings, roads and property. Thunder Tiger suggest user to use the product at specially designated areas.
- Please do not fly this product when affected by drunkenness, tiredness, drugs, dizziness fatigue, nausea or any other condition that might impair user's ability to control the drone.
- Please make sure all components of the product are connected well and working properly, otherwise, this product may be damaged, destroyed or even burnt. Also, make sure the power shall be disconnected and fuel must be retracted, if applicable, in order to avoid fire or explosion after using the product.
- Please do not use this product in unfavorable conditions.
- Please note that this product is intended for personal use and should never be used in a manner that infringes upon or contravenes international or domestic laws and regulations.
- User shall not use this product to:
  - (a) defame, abuse, harass, stalk, threaten or otherwise violate the legal rights (such as rights of privacy and publicity) of others;
  - (b) photograph people or their privacy area without their consent or photograph any non-photographing area without the prior authorizations;
  - (c) use this product for any illegal or inappropriate purpose other than general personal use (such as spy, unauthorized investigation and unauthorized detection);
  - (d) violate or disregard any other applicable local laws, administrative rules and social habits.
- Please be advised that in certain cases the copying of images and videos from shooting, performances, exhibitions, or commercial properties by means of a camera or other device may contravene copyright or other legal rights even if the image or video was shot for personal use.

## DISCLAIMER

- Read this disclaimer carefully before using this product. By using this product, user hereby agrees to this disclaimer and signifies that have read them thoroughly. Please strictly follow the instruction manual to assemble and use this product The manufacturer and seller assume no liability for any resulting damage or injury arising from the operation or use of this product.

## LIABILITY

- The products are sold as finished products, and Thunder Tiger is responsible to the extent for the quality of the products upon delivery to its customer. Any quality or specification issues arise from subsequent processing, modification, combination, use, compliance by Thunder Tiger with instructions provided by customer, any parts in the finished products that is provided or designated by customer, improper use of customer and any other reason not attributable to Thunder Tiger, are beyond the control scope of Thunder Tiger, which Thunder Tiger shall not be held liable for such quality issues.
- If there is any problem that cannot be solved, please contact the Thunder Tiger authorized dealers.

## LIMITATION OF LIABILITY

Thunder Tiger accepts NO liability for damage(s) or injuries incurred directly or indirectly from the use of this product in the following conditions:

- Damage(s) or injuries incurred when users are drunk, taking drugs, drug anesthesia, dizziness, fatigue, nausea and any other conditions no matter physically or mentally that could impair user's ability.
- Damage(s) or injuries caused by intentional operations.
- Any mental damage compensation caused by accident.
- Failure to follow the guidance of the product to assemble or operate.
- Malfunctions caused by refit or replacement with non-Thunder Tiger accessories and parts.
- Damage(s) or injuries caused by using third party products or fake Thunder Tiger products.
- Damage(s) or injuries caused by misoperation or subjective misjudgment.
- Damage(s) or injuries caused by mechanical failures due to wear and tear, erosion, aging.
- Damage(s) or injuries caused by continued flying or driving after low voltage protection alarm is triggered.
- Damage(s) or injuries caused by knowingly flying the aircraft is in abnormal condition (such as water, oil, soil, sand and other unknown material ingress into the aircraft or the assembly is not completed, the main components have obvious faults, obvious defect or missing accessories).
- Damage(s) or injuries caused by flying in the following situations such as the aircraft in magnetic interference area, radio interference area, government regulated no-fly zones or the pilot is in backlight, blocked, fuzzy sight, and poor eyesight is not suitable for operating and other conditions not suitable for operating.
- Damage(s) or injuries caused by using in bad weathers, such as a rainy day or windy, snow, hail, lightning, tornadoes, hurricanes etc.
- Damage(s) or injuries caused when the product is in the following situations, collision, fire, explosion, floods, tsunamis, subsidence, ice trapped, avalanche, debris flow, landslide, earthquake, etc.
- Damage(s) or injuries caused by infringement such as any data, audio or video material recorded by the use of product.
- Damage(s) or injuries caused by the misuse of the battery, protection circuit, RC model and battery chargers.
- Consequential damages caused by any malfunction of an equipment or accessory.
- Any consequences that caused by operations that do not follow all instructions in the quick start guide, detailed user guide and other useful information included in the package or the official website.
- Users do not obey the local law or regulation.
- Other losses that are not covered by the scope of Thunder Tiger liability.

## INTELLECTUAL PROPERTY

- The products may contain registered trademarks of Thunder Tiger. No part of this product or manual shall be reproduced in any form without the prior written consent or authorization of Thunder Tiger.

## GOVERNING LAW AND JURISDICTION

- The governing law of this matter shall be the laws of Taiwan (R.O.C.). All disputes related shall be resolved through good faith discussion. If such disputes cannot be resolved, it is hereby agreed to submit this matter to commercial arbitration in Taiwan in accordance to Taiwan arbitration law. The arbitration shall be submitted to The Arbitration Association of the Republic of China, and the arbitration shall be held in Taipei City. The arbitration award shall be final and binding to both parties, and shall be enforceable without obtaining court order.

## ADDITIONAL INFORMATION AND UPDATES

- Please see all attachments along with the products for more information, or visit the Thunder Tiger official website at [www.thundertiger.com](http://www.thundertiger.com) or [www.ttrobotix.com](http://www.ttrobotix.com) to refer to relevant updates or information.
- This Disclaimer provides the instruments for user's reference only, and shall not constitute as Thunder Tiger assumes any or all liabilities. User is obliged to ensure the accuracy of the information of the products, and shall update such information at the official website for the up-to-dated information.



## Declaration of Conformity

according to R&TTE Directive 1999/5/EC

For the following equipment:

Product : Explorer 1500 PRO  
Type Designation/Trademark : 4385 / Thunder Tiger  
Manufacturer's Name : Thunder Tiger Corp.  
Manufacturer's Address : No.7, 6th Road, Industry Park,  
Taichung, Taiwan 40755

- Council Directive 1995/5/EC R&TTE on radio equipment and telecommunications terminal equipment and the mutual recognition of their conformity

For the evaluation of the compliance with this Directives, the following standards were applied :

EN 61000-6-3 (2007+A1:2011+AC:2012)  
EN 61000-6-1 (2007)  
EN 61000-4-2 (2009)/-3 (2006+A2:2010)/-8 (2010)  
EN 61000-6-3 (2007+A1:2011)  
EN 61000-4-2 (2009)/-3 (2006+A2:2010)/-4 (2010)/-5 (2006)/-6 (2009)/-8 (2010)  
EN 301 489-1/-3  
EN 300 220  
EN 60950-1:2006

Responsible for making this declaration is the :

Manufacturer  Authorized representative established within the EU

EC Distribution

Company Name : THUNDER TIGER EUROPE GmbH  
Company Address : Rudolf-Diesel-Str. 1, 86453 Dasing, Germany

Person responsible for making this declaration

Name, Surname : Hawk Yang *Hawk Yang*  
Position/Title : Project Manager  
Date : February 2016



**Product/Produkt Name:** Explorer 1500 PRO

Item-No./Artikel-Nummer: 4385-F00

**Manufacturer/Hersteller:** Thunder Tiger Corp.

**Distributed by/Vertrieb:**

THUNDER TIGER EUROPE GmbH, Rudolf-Diesel-Str. 1, 86453 Dasing, Germany

**CAUTION**

Intended use: Partly assembled Aircraft Model for leisure activities. User has to finish the unit for operation by installing and adjusting a remote control (RC) radio-system, which is not part of the product. Product not intended for children under 18 years old. Contains small parts that may cause choking hazard. Keep out of reach of children under 3 years old.

**ACHTUNG**

Bestimmungsgemäße Verwendung: Teilmontiertes Flug-Modell zur Freizeitgestaltung. Der Nutzer muss die Einheit eigenständig für den Betrieb fertigstellen, indem er ein (RC) Fernsteuerungs-System installiert und gemäß allen, kombinierten Anleitungen justiert. Dieses Produkt ist ausdrücklich nicht dazu gestaltet oder offensichtlich dazu bestimmt, von Personen unter 18 Jahren verwendet zu werden. Abnehmbare Kleinteile können verschluckt werden. Erstickungsgefahr! Muss von Kindern unter 3 Jahren ferngehalten werden.

**Declaration of Conformity/CE Konformitätserklärung**

If for some reason the DoC should not be enclosed, it can be requested from mentioned distribution/ Sollte diese versehentlich nicht beiliegen, kann sie beim angeführten Vertrieb angefordert werden.



This product is not a toy. Before you assemble and use this product, please read this manual thoroughly. This product and its contents may differ from the graphics shown on this manual and are subject to change without prior notice due to product improvements and specification changes.

More information can view the tutorial videos on our TT official website ([www.thundertiger.com](http://www.thundertiger.com)) or YouTube channel (<https://www.youtube.com/user/ThunderTigerVideo>)